

## Picture

---

Section Details : Direct Set, 4 9/16" Jamb, Contemporary  
Section Details : Direct Set, 6 9/16" Jamb, Contemporary  
Section Details : Mull Sections  
Section Details : Sill Options  
Section Details : Frame Options  
Section Details : Exterior Trim Options  
Section Details : Nailfin Options

Picture

Section Details : C2 Frame, 4 9/16" Jamb

Direct Glaze  
Square Detail

SCALE: 3" = 1'-0"

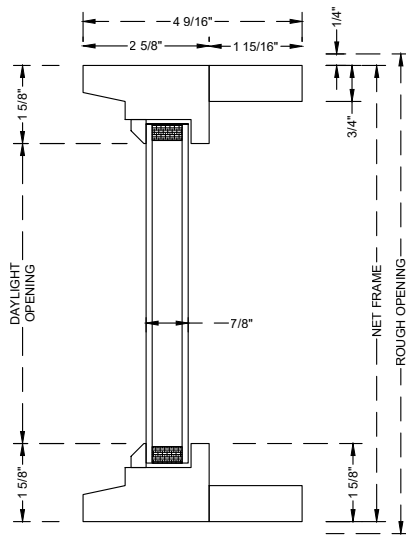

Head & Sill

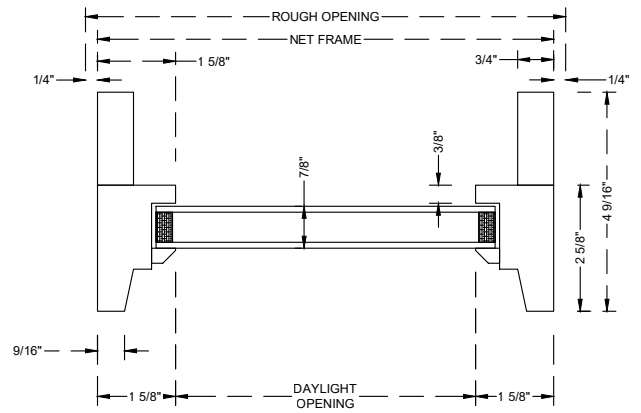

Jamb

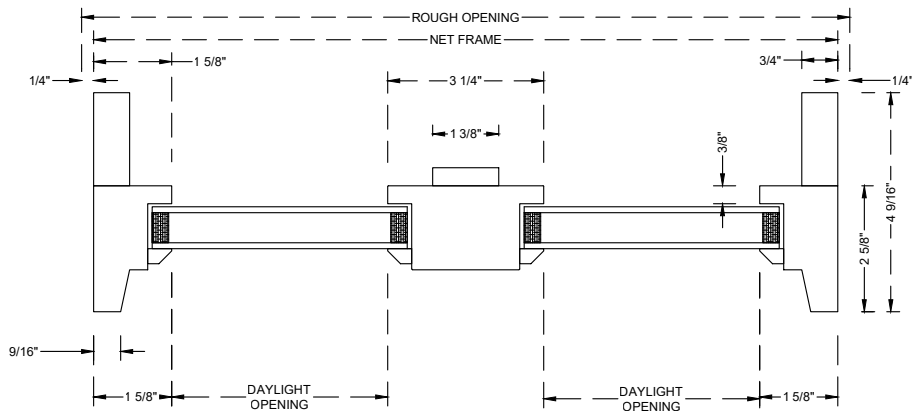

Standard T-Mull

Picture

Section Details : C2 Frame, 6 9/16" Jamb

Direct Glaze  
Square Detail

SCALE: 3" = 1'-0"

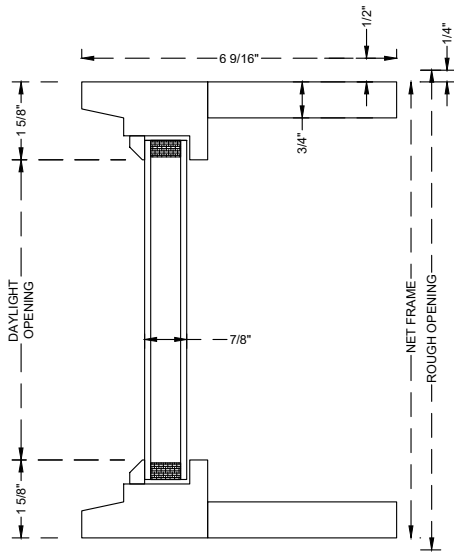

Head & Sill

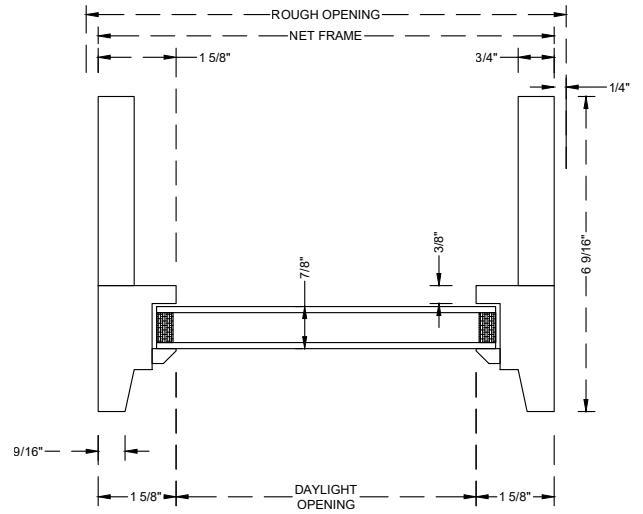

Jamb

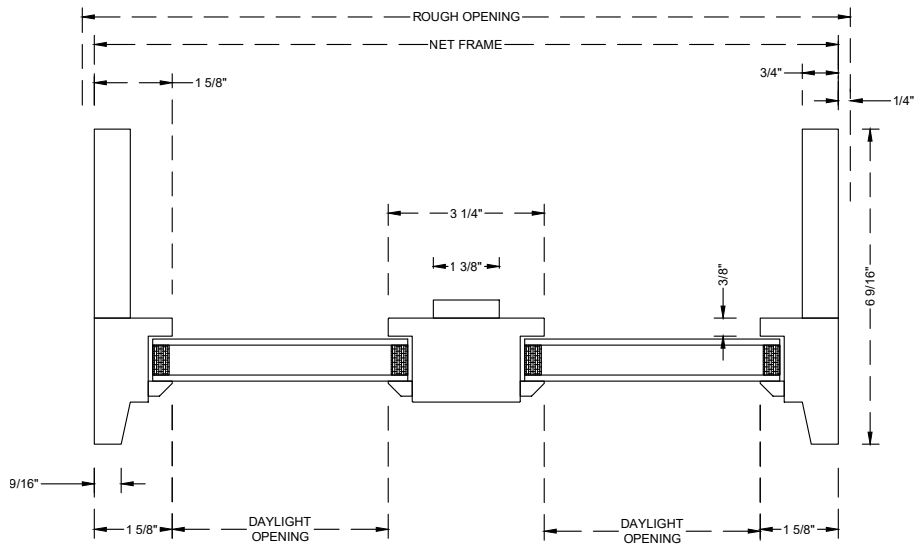

Standard T-Mull

Picture

Section Details : Mull Sections

SCALE: 3" = 1'-0"

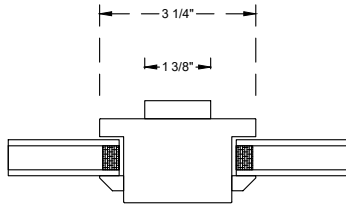

Standard Vertical T-Mull

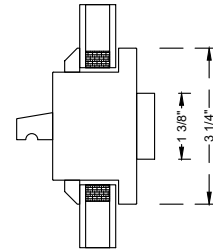

Standard Horizontal T-Mull

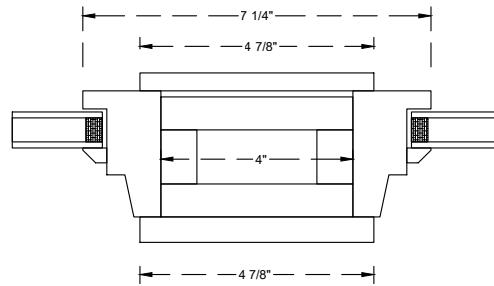

4" Spread Mull

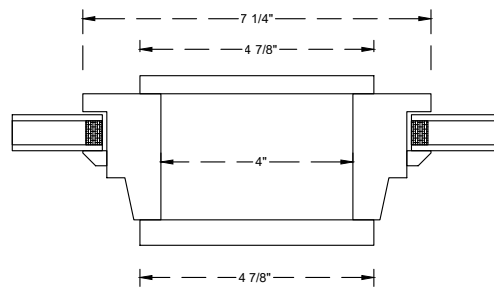

4" Space Mull

Picture

Section Details : Sill Options

SCALE: 3" = 1'-0"

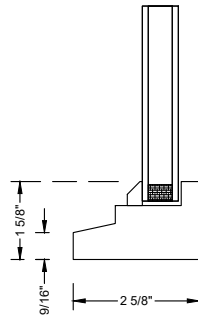

Standard (No Sub Sill)

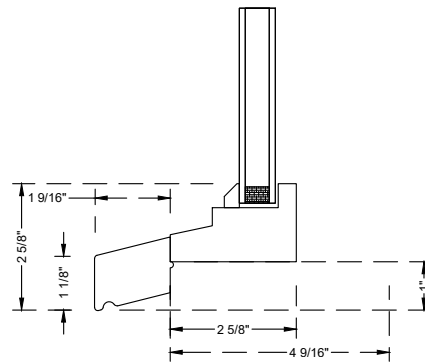

Subsill (2814)

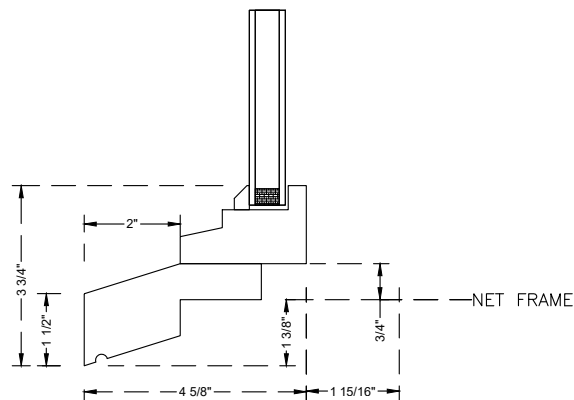

True Subsill (2816)

Picture

Section Details : Frame Options

SCALE: 3" = 1'-0"

Standard C2

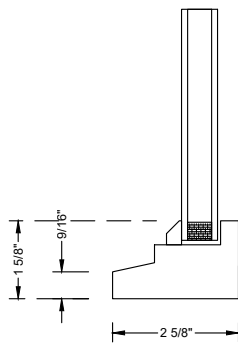

C2 Modified

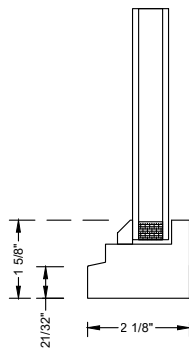

Picture

Section Details : Exterior Trim Options

SCALE: 3" = 1'-0"

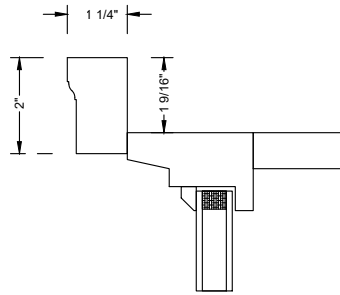

Brickmold Casing

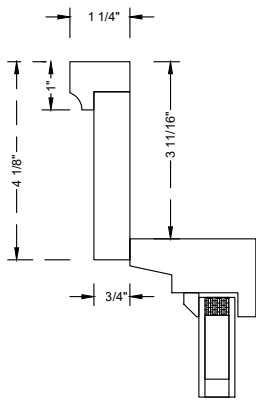

1 x 4 Casing w/ Backband

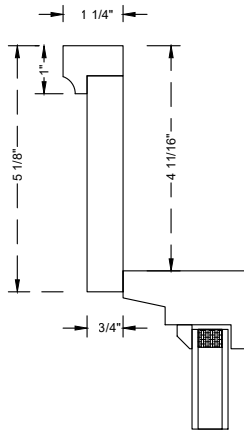

1 x 5 Casing w/ Backband

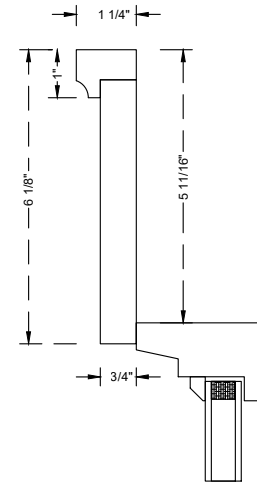

1 x 6 Casing w/ Backband

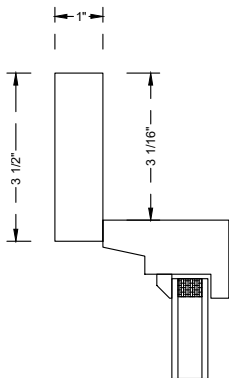

5/4 x 4 Casing

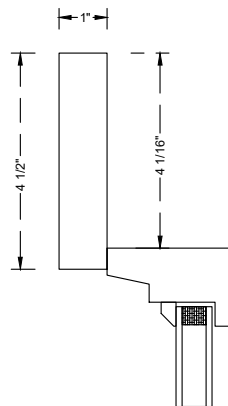

5/4 x 5 Casing

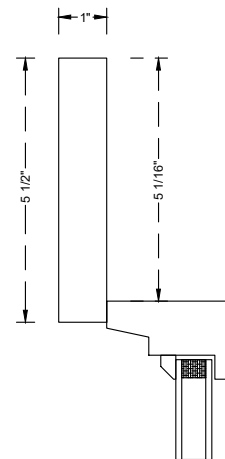

5/4 x 6 Casing

Picture

Section Details : Nail Fin Options

SCALE: 3" = 1'-0"

Flush Fin

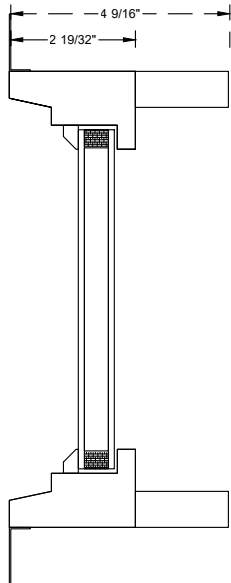

1 3/8 Setback Nail Fin\*  
\*Not compatible with brickmold or subsills

